

Introduction and Features

The SRK-RAM13H is a complete radio replacement kit with integrated climate control retention for select RAM trucks. All modules and cables are included to retain important features of the factory system, including: steering wheel-mounted radio controls, factory reverse camera, USB ports, and AM/FM reception.

Data integration with the vehicle and the Stinger HEIGH10 radio (sold separately) allows for the retention and addition of the following features: vehicle performance gauges and information, climate controls, vehicle settings, factory amplifier control, and forced camera activation. Simplified installation and setup menus allow direct programming of camera triggers, steering wheel controls, and other settings of the radio and CH4A-SRK interface.

Important Notes

We recommend reading this manual thoroughly to familiarize yourself with the entire process prior to beginning the installation.

1. Does Not Retain:

Cluster Display Features

- Compass (when equipped with 7" or 8.4" screen)
- Clock
- Phone pop-ups
- Navigation pop-ups

Factory Amplifier Features

- Speed Controlled Volume

Uconnect Features

- Uconnect Access Remote Start / Lock / Unlock
- SOS / Assist
- Vehicle Location Service
- WiFi-Hotspot

SiriusXM Guardian Services

- SiriusXM Radio

2. Ensure that the CH4A-SRK and PL1 modules have been updated to the latest version of firmware before installing into the vehicle. Refer to the Updating Firmware section at the end of the manual for firmware update instructions.
3. The vehicle should be OFF and key removed during entire disassembly and installation. Turning on the vehicle during the installation may cause error codes / check engine light.

Recommended Tools

Plastic Panel Tool

Phillips Screwdriver

7mm Socket

T20 Torx

Ratchet

Flush Cutters

Included Components

1. HEIGH10 Display Mounting Panel
2. Radio Module Mounting Brackets
3. External Chime Speaker
4. Media Hub Replacement (USBHUB-CH1-RCA)
5. AM / FM Antenna Adapter (BAA22)
6. PAC-LINK Interface Module (PL1)
7. CAN-Bus Connection Harness (MQS4PT-CANC)
8. Differential/Composite Video Modules x2 (RPA-VA1)
9. Main Wiring Harness (SRK-RAM13-HAR)
10. RadioPRO Replacement Interface Module (CH4A-SRK)
11. 6" Data Harness (10P-2-10P-6-HAR)
12. Satellite Antenna Adapter (SAT-01)

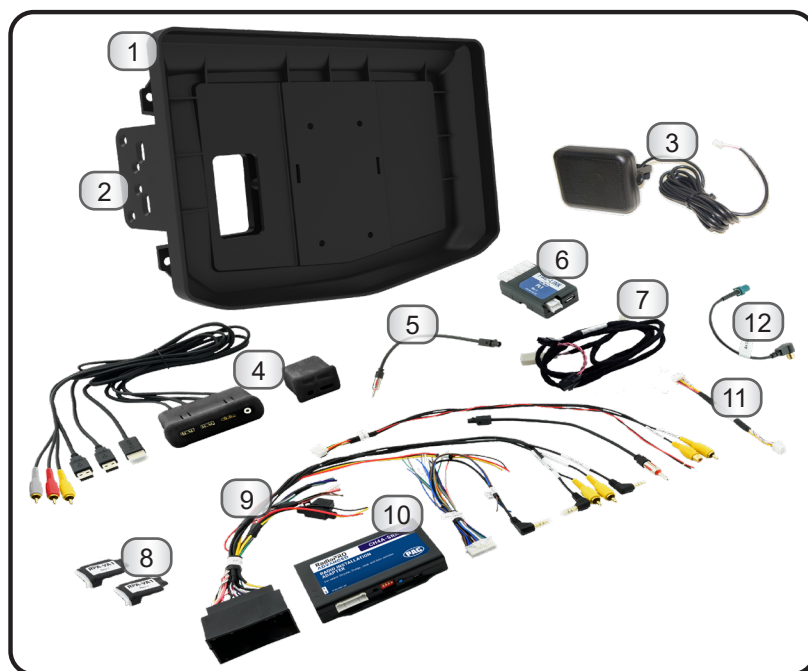

NOTE: Along with the SRK-RAM13H components, additional hardware and wire harnesses from the HEIGH10 (UN1810) kit will also be used in the installation. There is a component list, hardware guide, wire harness descriptions and illustrations in the UN1810 Installation Guide for reference.

Wiring Diagram Overview

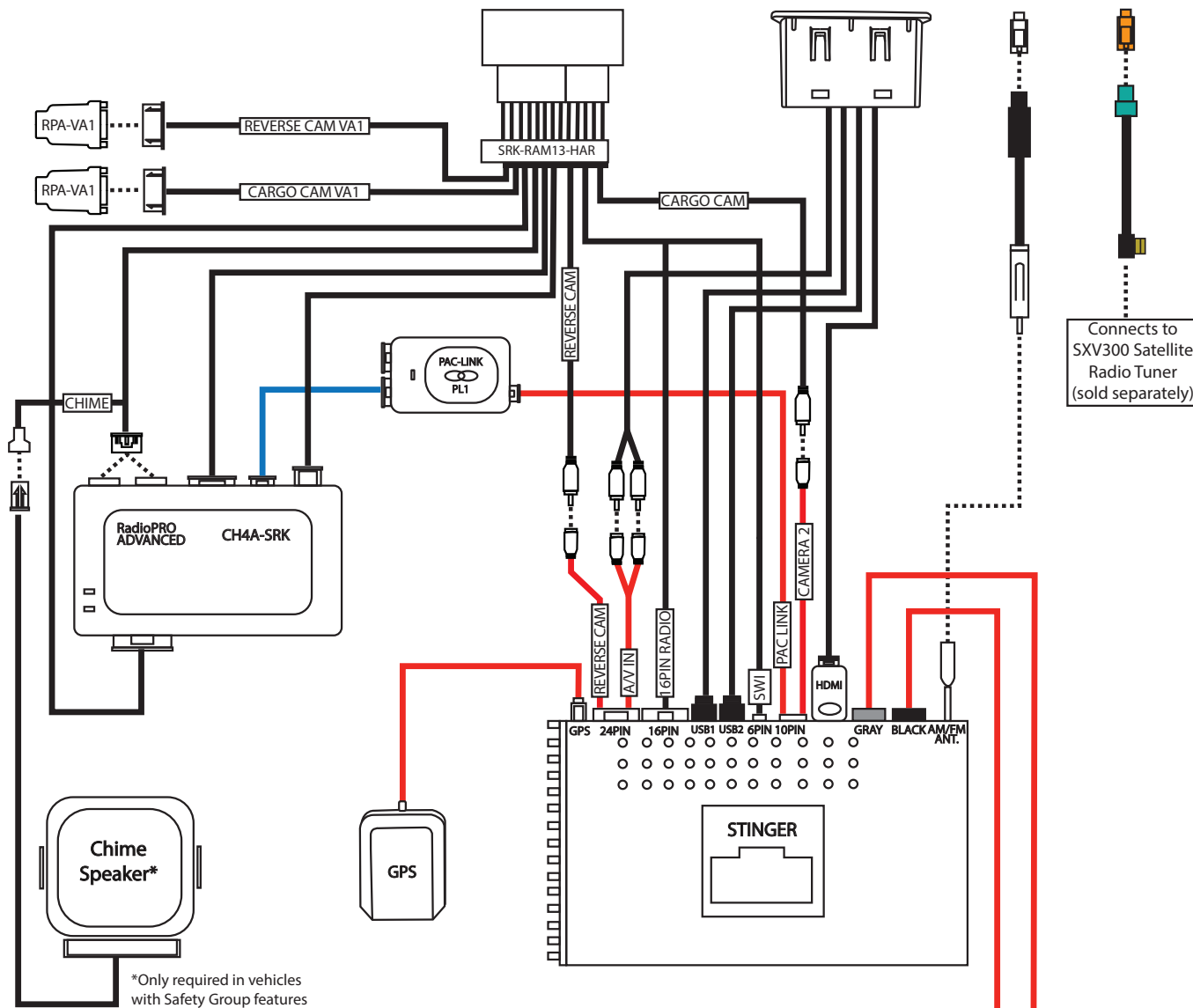

*Only required in vehicles with Safety Group features

- Main Harness Connection
- Stinger Connection
- PAC Connection

Connections shown are all required for full functionality of the kit and radio. If adding additional components, additional connections will be needed.

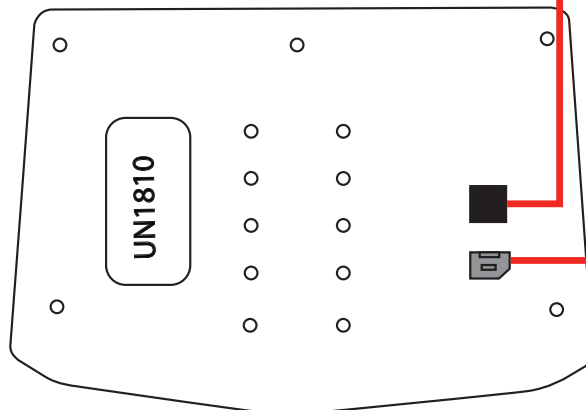

This installation manual will cover the necessary order of procedures to complete the installation efficiently and to avoid redoing any steps along the way. The order will be as follows: Disassembly, In-Vehicle Harness Connections and Preparation, Interface and Main Harness Connections, Display and Radio Unit Mounting Panel Preparation and Radio Unit Installation.

Section 1: Disassembly

Part One: Dash Disassembly - With Floor Mounted Center Console

If equipped with a floor mounted center console, begin here. If not, skip ahead to Part Two on page 4.



Step 1

Remove the circled rubber inserts to gain access to the screws securing the dash and console in place.



Step 2

Remove the two T20 Torx screws from the top of the dash.



Step 3

If present, remove the T20 Torx screw from the back of the small pocket on the right side of the dash.



Step 4

Remove the two Phillips head screws in the tray at the bottom of the dash panel.

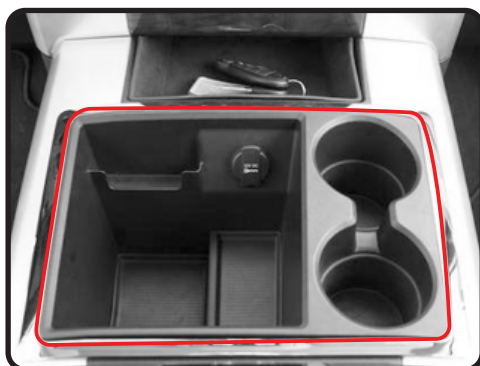

Step 5a

2013-2015 models: Remove the chrome trim ring around the center console storage compartment.

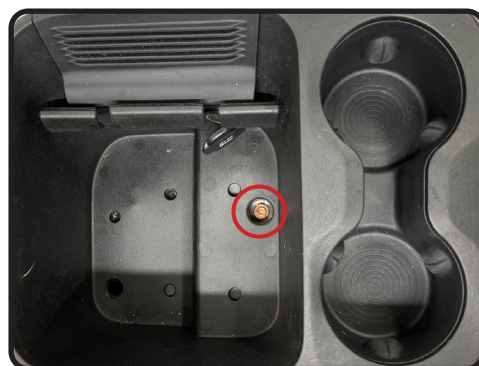

Step 5b

2016-2021 models: Remove the rubber insert in the bottom of the center console storage compartment. Remove the 7mm screw from the bottom of the storage compartment.

Section 1: Disassembly (cont.)



Step 6

Remove the center console by pulling straight up from the back and then pulling outward toward the back of the truck.



Step 7

Remove the dash panel by gripping firmly and pulling straight out on the top portion of the panel.

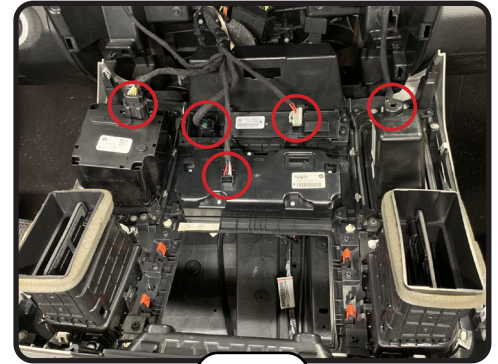

Step 8

Disconnect all the harnesses from the back of the dash panel and remove the dash panel from the truck.

Part Two: Dash Disassembly - Without Floor Mounted Center Console



Step 1

Remove the circled rubber inserts to gain access to the screws securing the dash panel in place.



Step 2

Remove the two T20 Torx screws from the top of the dash.

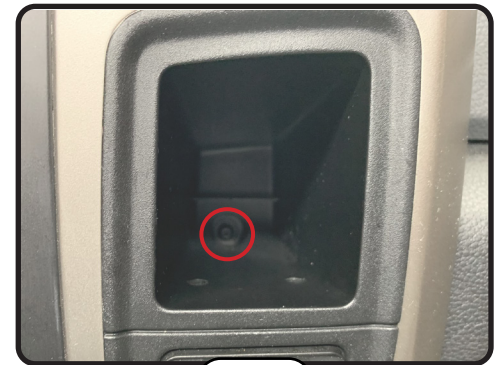

Step 3

Remove the T20 Torx screw from the back of the small pocket on the right side of the dash (not always present).



Step 4

Remove the dash panel by gripping firmly and pulling straight out on the top portion of the panel.

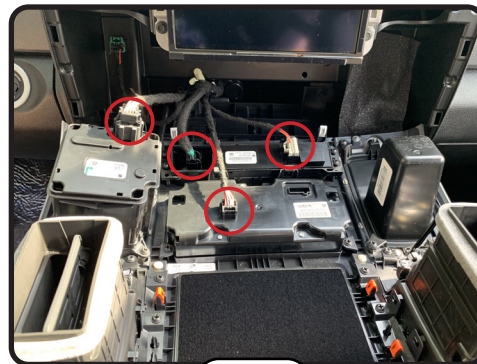

Step 5

Disconnect all the harnesses from the back of the dash panel and remove the dash panel from the truck.

Section 1: Disassembly (cont.)

Part Three: Radio Display Removal

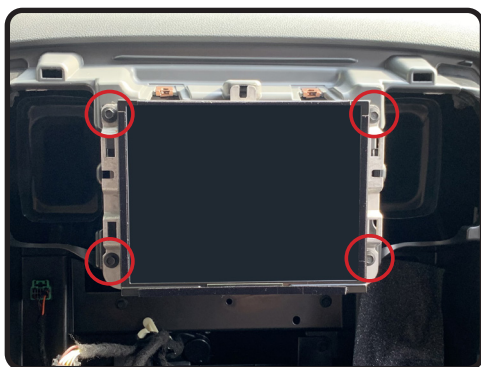

Step 1

Remove the four 7mm screws securing the radio display in place.



Step 2

Disconnect all the connectors from the back of the radio (the number of connections will vary based on the vehicle's available features).

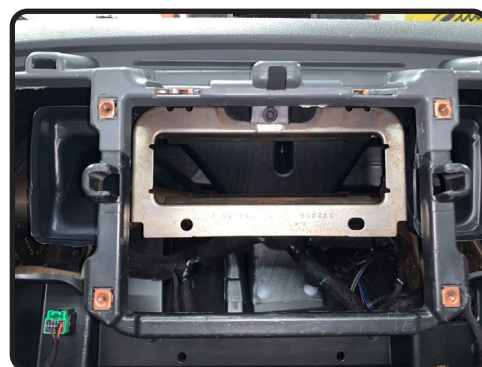

Step 3

Remove the display from the dash (dash appearance may vary according to model year).

Part Four: Floor Mounted Center Console Disassembly

If equipped with a floor mounted center console, proceed with the console disassembly steps listed below.
If equipped with a center seat mounted storage console, skip ahead to Part Five on page 7.



Step 1

Open the upper console storage and remove the rubber mat. Remove the seven inner tray T20 TORX screws. Remove the inner tray enough to access the wire harness connectors for the factory USB hub.

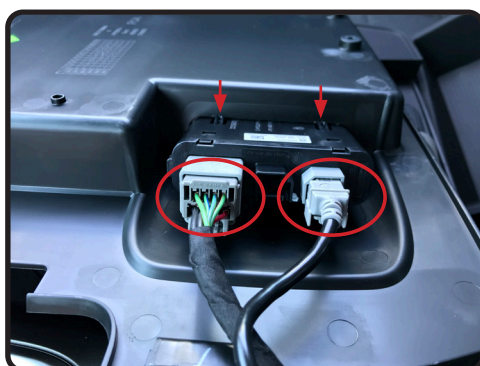

Step 2

Disconnect the two connectors from the factory USB hub. Compress the four retaining tabs on the USB hub to release and remove the hub assembly from the inner tray.



Step 3

Using a plastic trim tool, remove the center console rear panel by releasing the four retaining clips. Note: The rear power outlet can remain connected and the rear panel laid on the floor.

Section 1: Disassembly (cont.)

Part Four: Floor Mounted Center Console Disassembly (cont.)

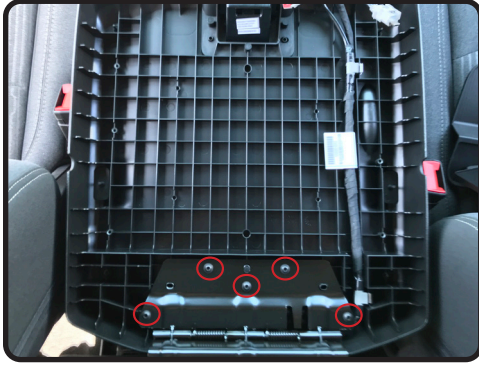

Step 4

Remove the five Torx T20 screws from the upper lid bracket and remove the upper console lid.

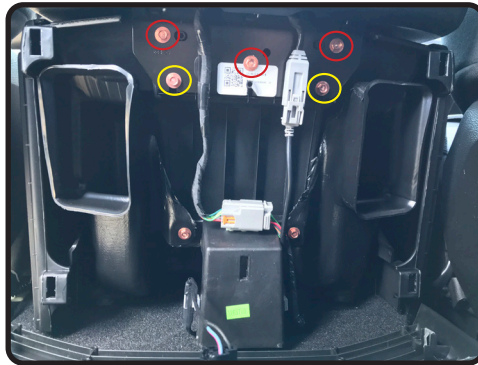

Step 5

At the rear of the console, remove the three 7mm screws from the lower lid bracket. Loosen the two lower 7mm screws. Unplug the two connectors and remove the upper console assembly.

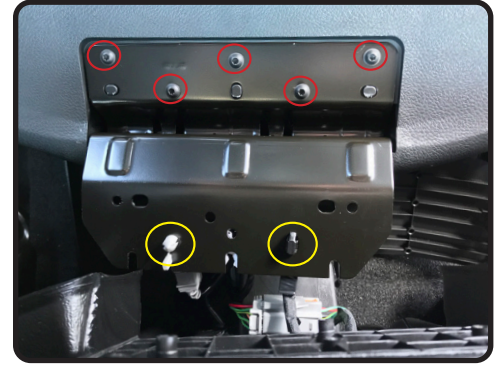

Step 6

On the backside of the upper console, remove the five Torx T20 screws securing the hinge. Unclip the console wire harnesses from the hinge and remove.

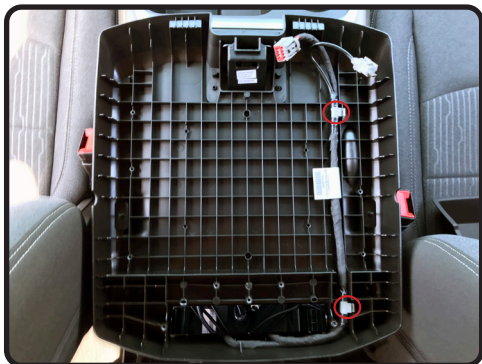

Step 4A

2016-2021 models:
Unclip and remove the factory USB wire harness from the upper console to allow room to route the replacement hub cables.

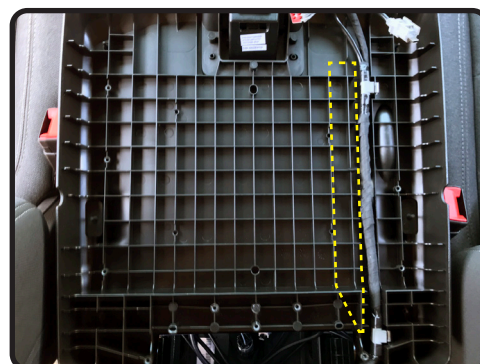

Step 4B

2013-2015 models: For trucks equipped with a 12V receptacle in the upper console, the factory wire harness will need to be reconnected. To allow space for routing the replacement hub cables, the plastic ribs will need to be trimmed flush in the area next to the factory wire harness.

OR

Section 1: Disassembly (cont.)

Part Five: Seat Mounted Storage Console Disassembly



Step 1

Using a plastic trim tool, remove the trim panel surrounding the cup holders.



Step 2

Starting on either side, pull and remove the spline attached to the fabric from the groove in the console.



Step 3

Continue to remove the fabric spline around the entire console.



Step 4

Tilt up the console and pull back the fabric to expose the foam padding.

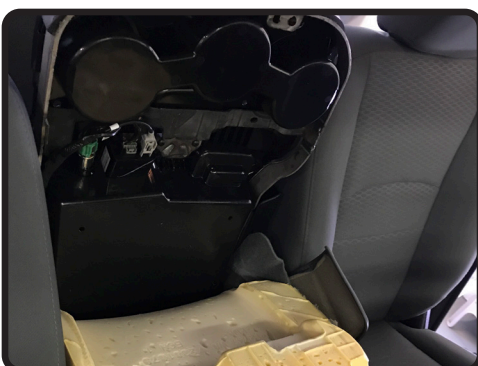

Step 5

Pull back the foam padding to access the back side of the USB hub.



Step 6

Unplug the two connectors from the factory USB hub. Compress the four retaining tabs on the hub to release and remove the hub assembly from the console.

NOTE: If the truck has an aftermarket leather interior installed, there may be spray adhesive holding the OEM fabric to the bottom of the console. This will need to be removed and then reattached with spray adhesive.

Section 1: Disassembly (cont.)

Part Five: Seat Mounted Storage Console Disassembly (cont.)



Step 7

Remove the Torx T45 screw from the passenger side hinge cover and remove cover.



Step 8

On the backside of the hinge cover, remove the rib by scoring with a utility knife and snapping the rib off.



Step 9

For access under the carpet, remove the passenger side door sill panel.

NOTE: The replacement media hub cables will be ran under the carpet from the center seat console to the radio opening. Removing the passenger seat will make this easier and provide more cable length at the radio opening, but is not necessary.

Part Six: Lower Knee Panel Removal (Optional)

NOTE: Removal of the lower knee panel is required for all 2018-2021 Classic model trucks and/or any truck equipped with Safety Group features (parking sensors).



Step 1

Remove the two 7mm screws from the bottom edge of the knee panel.



Step 2

Pull the panel to release the retaining clips and carefully lay the panel on the floor board.

Note: Disconnecting the OBD port and hood release attached to the panel is not required.

Section 2: In-Vehicle Harness Connections and Preparation

Part One: Media Hub Installation (Floor Mounted Center Console)

If equipped with a floor mounted center console, proceed with the installation steps listed below.
If equipped with a center seat mounted storage console, skip ahead to Part Two on page 9.

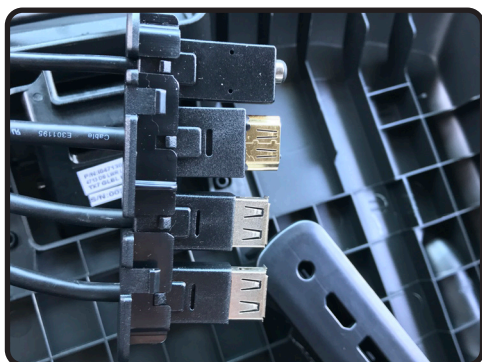

Step 1

Select the correct media hub plastic assembly for the vehicles console type and assemble the media hub.



Step 2

Feed the cables through the console tray opening and install the hub into the console inner tray.



Step 3

Zip tie and route the cables to the rear of the console following the channel in the bottom of the console.

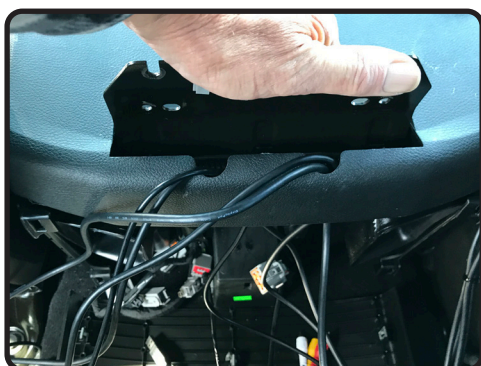

Step 4

With the media cables routed through cut-outs on the bottom of the upper console, reinstall the hinge using the five Torx T20 screws removed in disassembly.

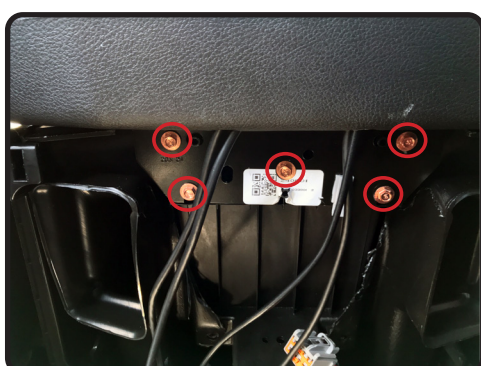

Step 5

Position and reattach the upper console to the lower console using the 7mm screws removed in disassembly. 2013-2016 models: Connect the factory connectors to the upper console wire harness.



Step 6

Following the factory wire harness, route the four media cables forward under the lower console into the area under the cup holders and then up into the radio opening.

Section 2: In-Vehicle Harness Connections and Preparation (cont.)

Part Two: Media Hub Installation (Seat Mounted Storage Console)

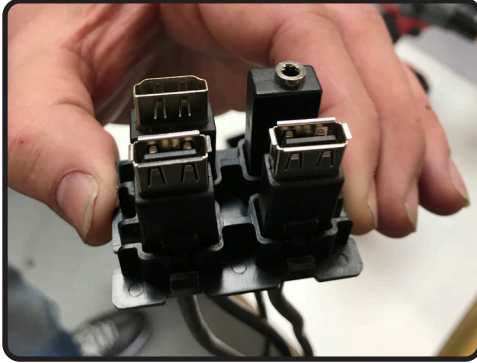

Step 1

Select the correct media hub plastic assembly for the vehicles console type and assemble the media hub.



Step 2

Feed the cables through the factory opening and install the hub into the console inner tray.



Step 3

Following the factory harness, route the media cables down under the passenger seat. Zip tie securely to the factory harness to ensure console hinge cover will fit properly when reinstalled.



Step 4

Feed the cables under the carpet; either using the pre-existing hole for the air bag harness or cutting a new hole closer to the center of the vehicle.



Step 5

Remove the lower panel under the center storage drawer (1). Route the cables (under the carpet) to the opening at the base of the center dash area.

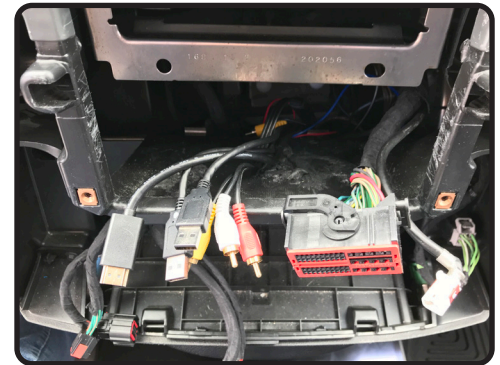

Step 6

Route the media cables up into the lower radio opening, below the metal bracket.

Section 2: In-Vehicle Harness Connections and Preparation (cont.)

Part Three: GPS Antenna / AM/FM Antenna Adapter (BAA22)

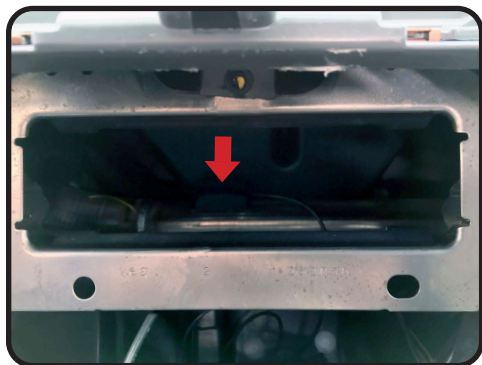

Step 1

From the HEIGH10 box, position the magnetic GPS antenna on the metal bar running across the back of the sub-dash at the rear of the radio opening.



Step 2

Route the blue GPS antenna connector below the metal support bracket. Bundle and secure the excess cable in the rear of the radio opening.

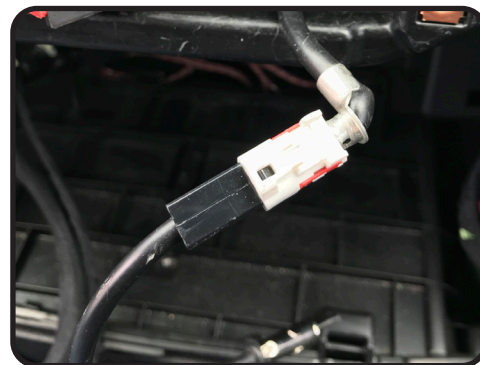

Step 3

From the SRK-RAM13H components, connect the BAA22 antenna adapter to the white factory antenna connector.

Part Four: Chime Speaker (Optional)

Note: Installation of the chime speaker is only required in trucks equipped with Safety Group features (parking sensors).

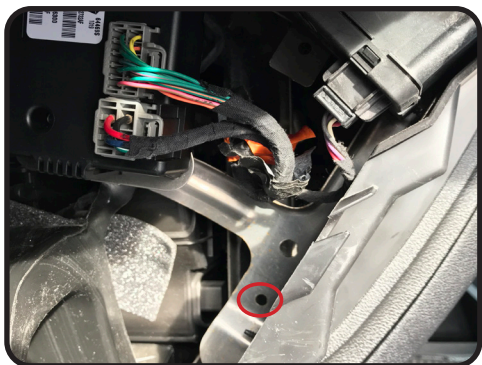

Step 1

To the right of the steering column, locate the indicated hole on the metal brace. Remove the knobs from the chime speaker and separate it from the mounting bracket.



Step 2

Using the existing hole, mount the chime speaker bracket to the metal brace using one of the supplied mounting bolts and wing nuts. Drill a second hole and install the other bolt and wing nut.

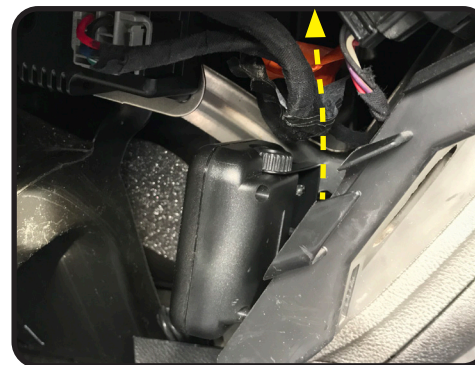

Step 3

Reattach the speaker to the mounting bracket. Route the chime speaker cable up to the radio opening leaving enough slack to connect to the SRK-RAM13 main harness.

Section 2: In-Vehicle Harness Connections and Preparation (cont.)

Part Five: CAN Connection Harness - MQS4PT-CANC (Optional)

Note: Installation of the CAN Harness is only required for 2018 and newer trucks.



Step 1

To the left of the steering column, locate the green CAN connection blocks with white plugs. Route the white 2-pin connector end of the MQS4PT-CANC harness from the radio opening to the CAN connection block.

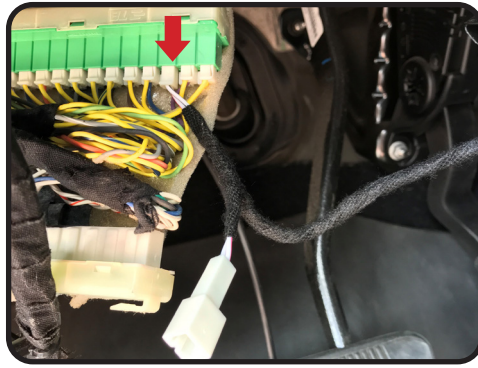

Step 2A

Plug the male white connector from the MQS4PT-CANC harness into any open spot on the green CAN junction block. The female connector on the MQS4PT-CANC will not be used.

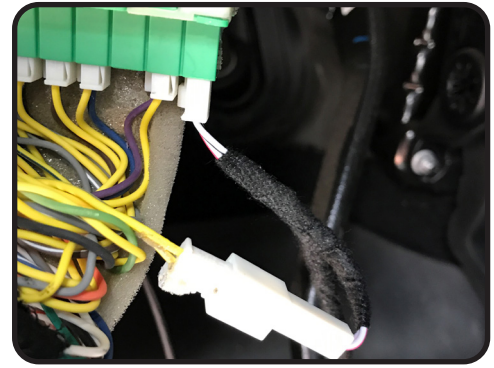

Step 2B

OR

If there are no open ports on the CAN junction block, unplug one factory male connector and insert it into the female connector on the MQS4PT-CANC harness, then insert the male connector on the MQS4PT-CANC harness into the now empty port on the CAN junction block.

Section 3: Interface and Main Harness Connections and Preparation

Part One: CH4A-SRK Radio Interface Connections



Step 1

Connect the three connectors from the SRK-RAM13-HAR Main Harness to the indicated ports on the CH4A-SRK module.



Step 2

Referencing the sticker on the back, connect the fourth connector to the appropriate port. *Amplified* if the truck has a factory amplifier, *Non-Amplified* for base audio.



Step 3

Connect one end of the 6" Data Harness (10P-2-10P-6-HAR) to the CH4A-SRK Expansion Port and the other end to either port on the PAC-LINK (PL-1)



Section 3: Interface and Main Harness Connections and Preparation (cont.)

Part Two: Main Harness Connections

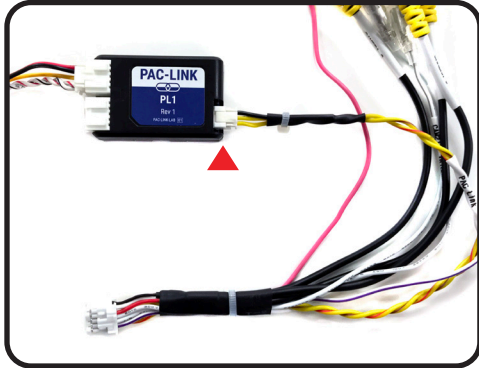

Step 1

From the HEIGH10 wire harnesses, connect the 3-pin PAC-Link lead on the 10-pin Multi Camera Harness to the PL-1.

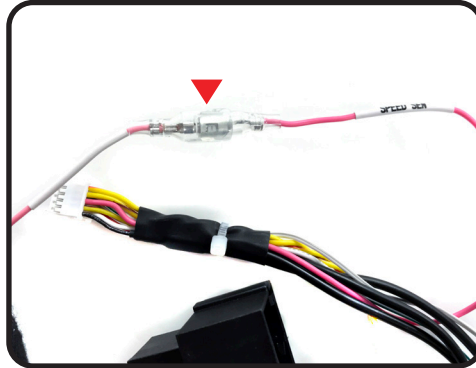

Step 2

Connect the pink SPEED SEN lead on the Main Harness to the pink SPEED SEN lead on the 10-pin Multi Camera Harness.

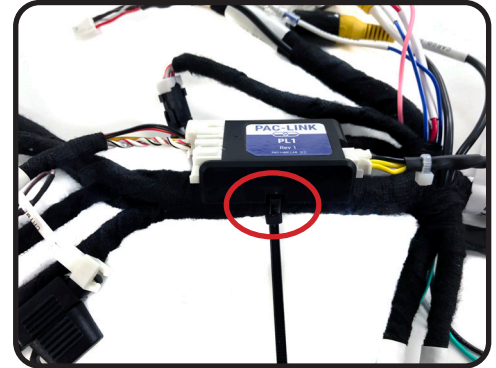

Step 3

Zip tie the PAC-Link (PL-1) to the main harness.

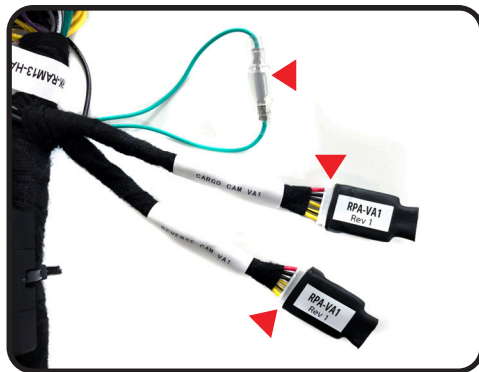

Step 4

Connect the male and female ends of the Light Green leads together. If factory equipped, connect a RPA-VA1 to REVERSE CAM VA1 and CARGO CAM VA1.

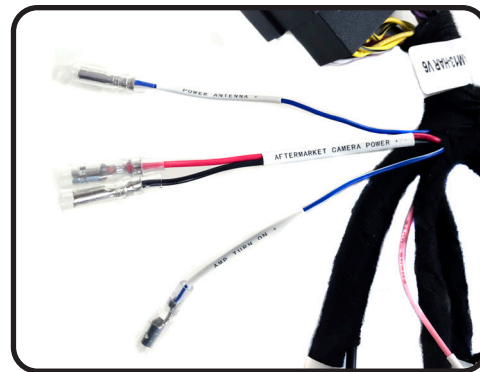

Step 5

The SRK-RAM13H-HAR Main Harness also provides Aftermarket Camera Power/Ground, Amp Turn On and Power Antenna leads if needed.

Section 4: Display & Radio Unit Mounting Preparation

Part One: Display Mounting Panel

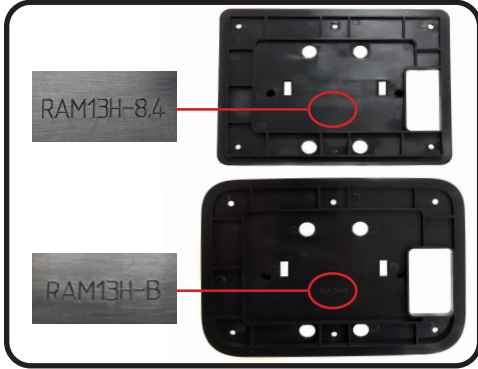

Step 1

From the SRK-RAM13H kit, choose the appropriate mount plate. *RAM13H-8.4* is used when replacing an 8.4" factory display and *RAM13H-B* is used for all others.

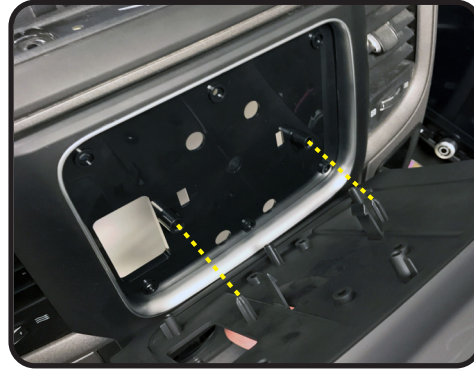

Step 2

Position the mount plate on the backside of the dash panel opening with the cut-out on the left side. Align the two locator pins on main frame to the mount plate and push to snap together.



Step 3

Place the HEIGH10 display into the main frame. While holding the display, carefully turn over the panel and place it face down on a soft surface.

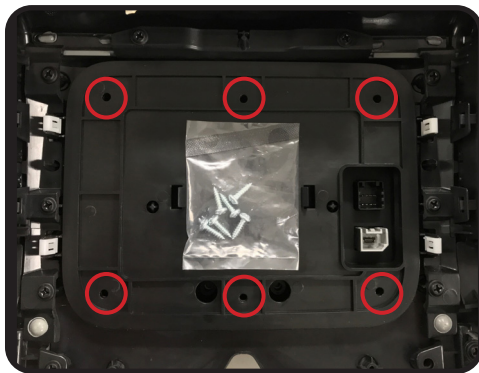

Step 4

Install six M4x12 Philips screws from the SRK-RAM13H kit to secure the mounting plate and main frame to the dash panel.

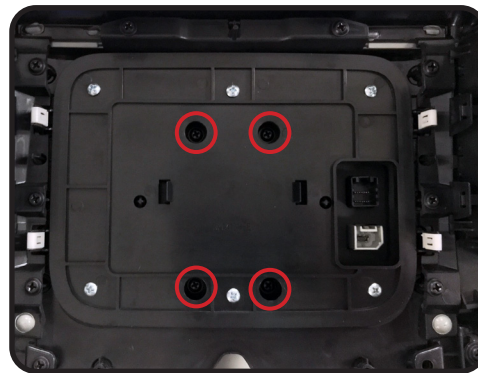

Step 5

Install four M4x10 screws from the HEIGH10 hardware pack to secure the display in the mounting panel.

Section 4: Radio Unit & Display Mounting Preparation (cont.)

Part Two: Attaching Side Brackets



Step 1

With the radio module facing up, loosely attach a side bracket using two M5x10 screws from the SRK-RAM13H hardware. Slide the bracket as far down as it will go and tighten the screws.



Step 2

Attach the other side bracket using two M5x10 screws. Ensure the bracket is positioned as far down as possible.

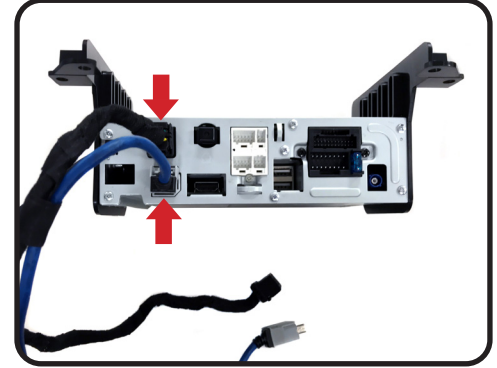

Step 3

From the HEIGH10 harnesses, plug in the blue LVDS and 10-pin display harnesses into the radio module.

Section 5: Radio Unit Installation

Part One: Harness and Cabling Connections

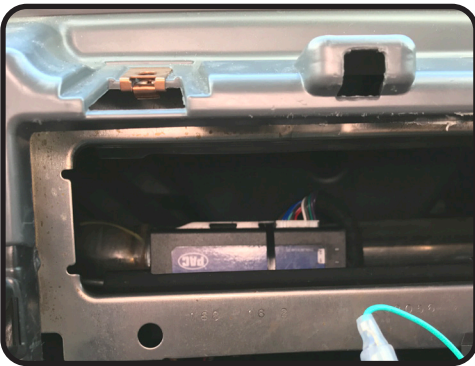

Step 1

Using the long zip tie from the SRK-RAM13H hardware, mount the CH4K-SRK module to the metal bar and wire harness at the rear of the radio cavity.

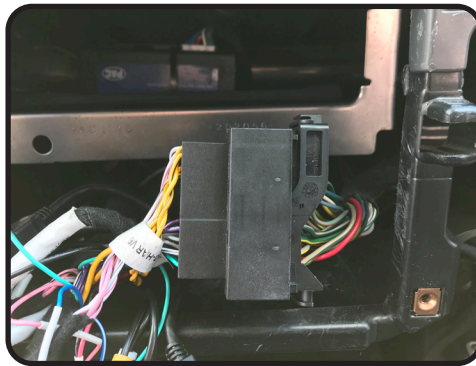

Step 2

Connect the 52-pin dock-and-lock connector on the SRK-RAM13-HAR Main Harness to the OEM radio connector in the vehicle.



Step 3

If installed, connect the 2-pin Chime Speaker connector to the 2-pin connector labeled CHIME on the SRK-RAM13-HAR Main Harness.

Section 5: Radio Unit Installation (cont.)

Part One: Harness and Cabling Connections (cont.)

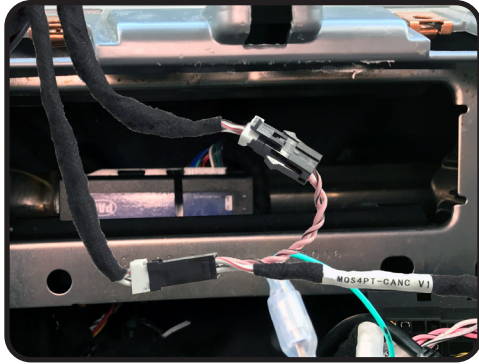

Step 4

2018+ Models Only: Disconnect the 4-pin connectors on the SRK-RAM13-HAR Main Harness. Connect the MALE 4-pin connector on the MQS4PT-CANC harness into the FEMALE 4-pin connector and the MALE connector into the FEMALE.

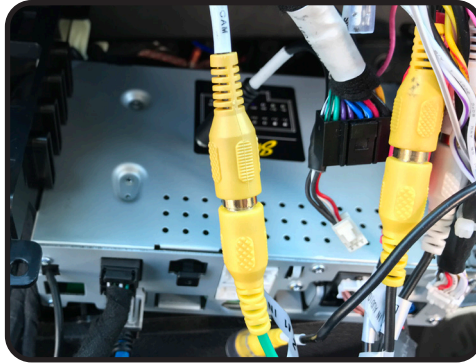

Step 5

If equipped with an OEM rear camera, connect the REVERSE CAM RCA on the SRK-RAM13-HAR to the REVERSE CAMERA IN RCA on the HEIGH10's 24-pin AV Harness. Or alternatively, connect an aftermarket camera to REVERSE CAMERA IN.



Step 6

If equipped with an OEM cargo camera, connect the CARGO CAM RCA on the SRK-RAM13-HAR to the CAMERA 2 input on the HEIGH10's 10-pin Multi Camera Harness.



Step 7

Connect the Red, White and Yellow RCA's from the media hub to the AUX IN inputs on the HEIGH10's 24-pin AV Harness.

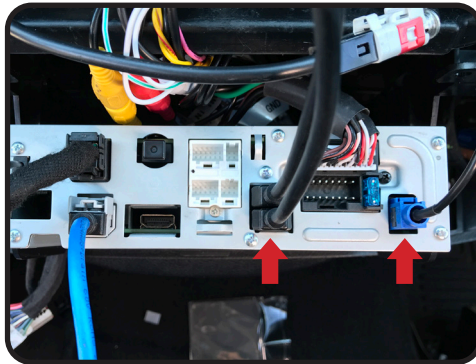

Step 8

Plug the two USB cables into the HEIGH10 USB ports. Connect the GPS antenna connector.

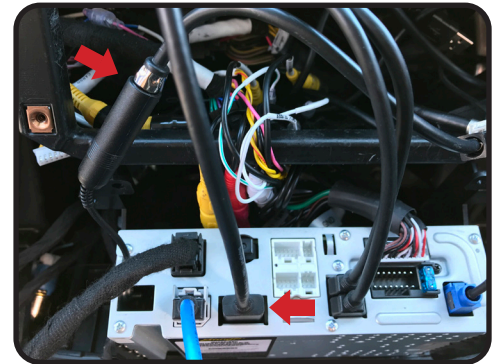

Step 9

Connect the AM/FM antenna lead to the HEIGH10 antenna input. Plug in the HDMI cable.

Section 5: Radio Unit Installation (cont.)

Part One: Harness and Cabling Connections (cont.)

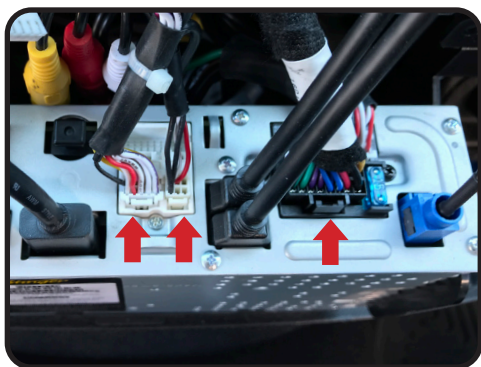

Step 10

From the SRK-RAM13-HAR, plug in the HEIGH10 10-pin Multi Camera Harness, 6-pin SWC/IR Harness and 16-pin Main Radio Harness.

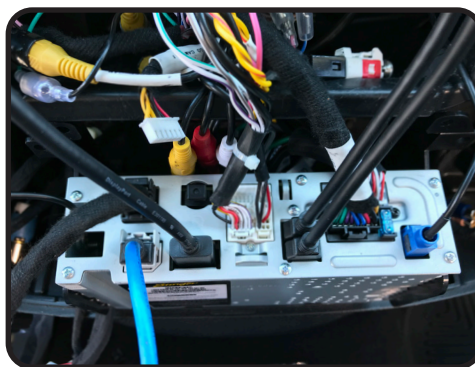

Step 11

These are the connections for the basic installation. If adding additional components, those connections should be made at this point, before mounting the radio module.

Part Two: Radio Unit Mounting

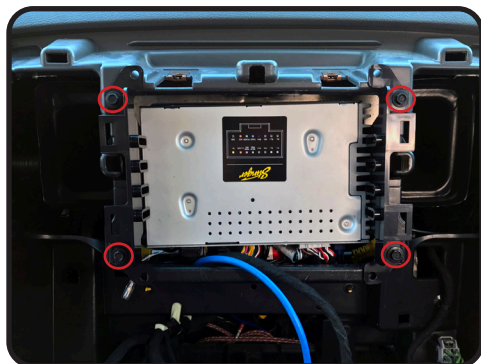

Step 1

With the two display cables routed out towards the front, position the radio assembly in place and install the four 7mm screws removed from the factory radio display.

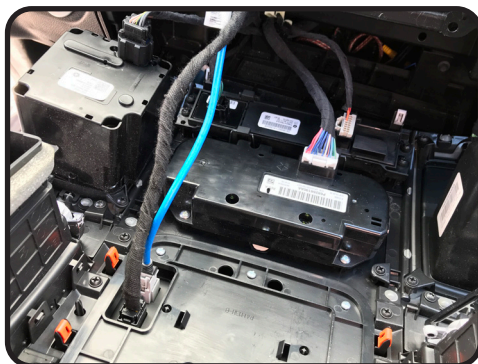

Step 2

Plug the two display cables into the back of the HEIGH10 display. Reconnect all the factory connectors removed from the back of center dash panel.



Step 3

Align the center dash panel in place and push around entire panel to fully seat all retaining clips.

! Before turning on the ignition, close all the doors and lock the truck with the key fob. Wait five minutes and then unlock and start the vehicle. The initial boot up may take up to 30 seconds before the display is active. Do not press the power button or turn off the vehicle during this time. Once powered up, refer to the SRK-RAM13H Installer Set-Up Guide for access to the Installer Settings.

Troubleshooting

- Vehicle Info icon not showing on main menu** - After updating the Radio System Firmware, perform a master reset on the radio by tapping “Master Reset” in the “Installer Settings”; then, update the PAC Application APK firmware in that order. If the Vehicle Info icon still does not show, turn off the vehicle, open the driver door, and let it sleep for about 5 minutes, then restart the vehicle and check for the Vehicle Info icon again.

CH4A-SRK Interface Module LED Diagnostics

LED Pattern	State	Action
LED 2 solid red	Vehicle RAP / ACC Output Is On	N / A
LED 2 flashing green	SWC Activity	N / A
LED 2 flashing red	Module Resetting / Initializing	N / A
LED 1 solid green	Module Powered and Operating	N / A
LED 1 flashing amber	USB Connected	N / A
Off	No Activity	Verify key is in ignition position. Verify that there is 12v on the yellow wire and ground on the black wire.

PL1 Adapter Module LED Diagnostics

LED Pattern	State	Action
LED flickering green or red	Data Communication / Normal Operation	N / A
Off	No Activity	Verify 10pin harness connections and key position

Product Updates (Firmware)

Firmware Updates (RadioPRO and PL1 Interface Modules)

The RadioPRO PC app will allow you to update the interface modules with new firmware as it becomes available. Please visit www.PAC-audio.com/firmware to download available updates.

To update an interface module, open the RadioPRO PC app, connect the interface to your PC via a micro USB cable, and select “Firmware” and then “Update Firmware”.

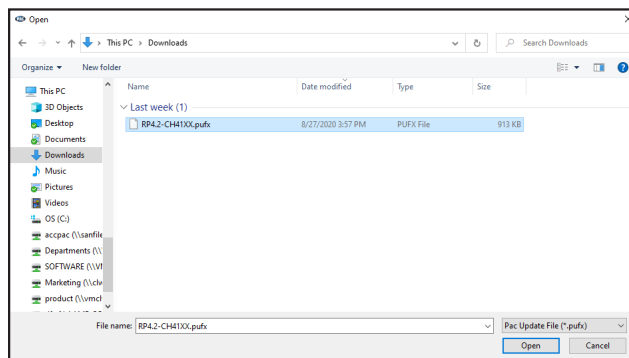

Now, select “Select File”. Finally, browse to the place where you saved the file, and select it. This will begin the updating process. Once finished, disconnect the interface from the PC. Repeat for each module: CH4A-SRK and PL1.

Firmware Updates (Stinger Radio and PAC Application APK)

To update the Stinger radio firmware and PAC Application APK firmware, refer to the Installer Setup Guide for an in-depth walk-through on how to perform these updates on your Stinger radio unit.

Reset / Restoring Interface Factory Settings

You can restore the RadioPRO interface module to factory default settings by pressing and holding the programming button on the side of the module until the status LED starts blinking red. Once the LED starts blinking red, release the button. You must release the button while the LED is blinking red in order to perform the reset. This reset will restore all settings to factory defaults.

Technical Support

Email: support@PAC-audio.com
Phone: 866-931-8021
International: 727-592-5991

